

Flexy Compact

Refrigerated well on cupboard with refrigerated display, compact (4GN) with wheels, overshelf with L

ITEM # _____

MODEL # _____

NAME # _____

SIS # _____

AIA # _____

322038 (F19C4AW00S)

Refrigerated well on cupboard with refrigerated display, compact (4 GN container capacity) with wheels, overshelf with LED lights and two stainless steel tray sliders, H=900mm (Nordic)

ensure maximum hygiene of the food. Includes 2 adjustable shelves composed of two grids each. The shelves can be adjusted in height to allocate different items. Wells in 304 AISI stainless steel with rounded corners to facilitate cleaning operations. The well is also equipped with a drain hole. High-density expanded polyurethane foam with cyclopentane guarantees excellent well insulation to reduce energy dispersion. R290 refrigerant gas (GWP=3) to reduce environmental impact and increase cooling efficiency. 900mm worktop height.

Short Form Specification

Item No. _____

Compact design, ideal for space saving environments. AISI 304 Foldable tray sliders on long sides. Unit mounted on 125 mm wheels 2 swivel and 2 with brakes. Soft closing doors on operator side. Underneath ambient cupboard with doors. Sturdy body construction with laminated panelings on 4 sides. Designed to serve: Plates on the shelves and food in GN containers or food on plates/packages or bottles and cans thanks to adjustable bottom well. Suitable for GN 1/1 containers with a maximum height of 200 mm. Food introduced at the correct temperature maintains its core temperature according to Afnor Standards. Automatic defrosting guarantees evaporators clearance and efficient well cooling. Digital control with temperature display with precise adjustment (0,1°C). Fully compliant HACCP digital controls include visible alarms. The unit is composed of two refrigeration systems: a static cooled well on the bottom and evaporator with fan on the top. Short sides and the top are in double glazed low emission glass (18 mm thick) to improve insulation avoiding formation of the condensation and reducing energy consumption. The display is illuminated by inside LED light under each glass shelf that emphasizes the cold food colors. The temperature uniformity is guaranteed by fans and an high surface evaporator placed at the top of the unit. Plexiglass display case with lift-up doors on both sides to

APPROVAL: _____

Main Features

- Precise temperature control and setting at 0,1°C .
- As standard the product comes with digitally controlled thermostat which is in line of HACCP norms and provides visual alarm as a warning of the increasing or decreasing temperatures.
- Food introduced at the correct temperature maintains its core temperature according to Afnor Standards.
- Automatic defrosting guarantees evaporators clearance and efficient well cooling.
- Suitable for GN 1/1 containers with a maximum height of 200 mm.
- The unit is composed of two refrigeration systems: a static cooled well on the bottom and evaporator with fan on the top.
- Bottom well is designed to serve the food in GN containers or bottles and cans.
- The display is illuminated by inside LED light under each glass shelf that emphasizes the cold food colors.
- The temperature uniformity is guaranteed by fans and an high surface evaporator placed at the top of the unit.
- The configuration allows a compact footprint and excellent preservation performances.
- Plexiglass display case with lift-up doors on both sides to ensure maximum hygiene of the food.
- Includes 2 adjustable shelves composed of two grids each. The shelves can be adjusted in height to allocate different items.
- Perfect compact design makes it ideal for space saving environments.
- CB and CE certified by a third party notified body.
- Soft closing doors on operator side.
- Underneath ambient cupboard with doors ideal for extra storage.
- Available options with online configurator: colors, tray sliders, overshelves, feet/wheels with desired diameter, height 750mm for kids.
- Optional plinth can be installed to cover the feet or the wheels.
- AISI 304 Tray slider in flush mounted stainless steel is installed on long sides and they can also be folded down to facilitate passage of the units through doorways.
- Ideal for servery lines without an operator.
- Unit mounted on 125 mm wheels 2 swivel and 2 with brakes.
- Available dimensions: 2, 3, 4 GN.

Construction

- Electronic control with temperature display.
- Well bottom is inclined to facilitate water drainage.
- Well in 304 AISI stainless steel with rounded corners to facilitate cleaning operations. The well is also equipped with a drain hole.
- IPx2 water protection.
- Top in AISI 304.
- Sturdy construction with laminated panelings on 4 sides.

Sustainability



- Hydrocarbon refrigerant gas R290 for the lowest environmental impact (GWP=3) - CFC and HCFC free.
- High-density expanded polyurethane foam with cyclopentane guarantees excellent well insulation to reduce energy dispersion.

- Short sides and the top are in double glazed low emission glass (18 mm thick) to improve insulation avoiding formation of the condensation and reducing energy consumption.

Front

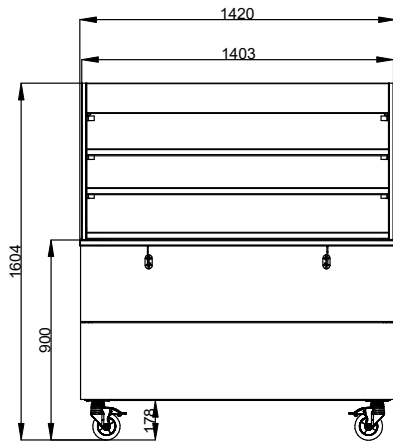

Side

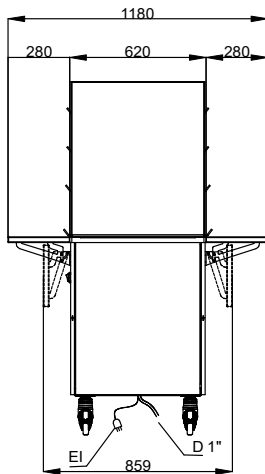

D = Drain
EI = Electrical inlet (power)

Top

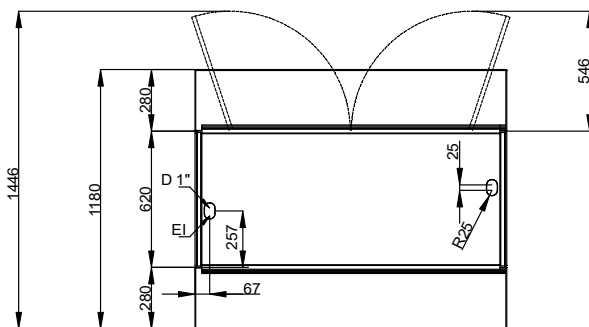

Electric

Supply voltage: 220-240 V/1N ph/50 Hz
Electrical power, max: 1.07 kW

Key Information:

N° of doors: 2
External dimensions,
Width: 1420 mm
External dimensions,
Depth: 1180 mm
External dimensions,
Height: 1605 mm
Shelves number: 2
Net weight: 286.5 kg
Shipping height: 1800 mm
Shipping width: 920 mm
Shipping depth: 1470 mm
Shipping volume: 2.43 m³
Set temperature: +4 / +8 °C
Top temperature: +4 / +8 °C

Sustainability

Noise level: 64 dBA